

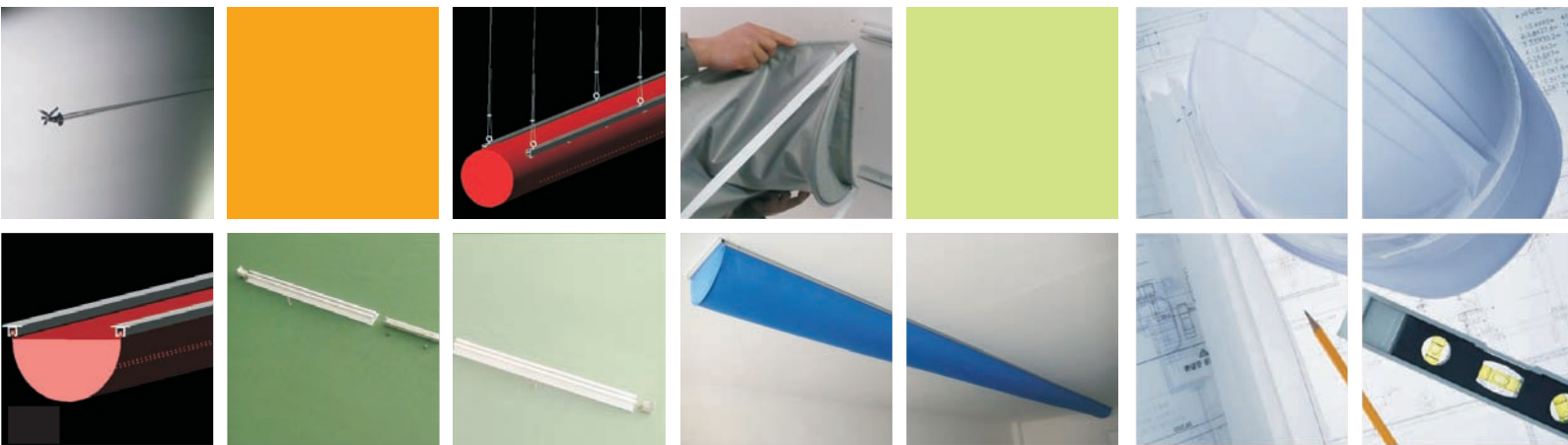

THE EXPERT IN AIR DISPERSION INDUSTRY WORLD WIDE



# **INSTALLATION MANUAL**

## **OF TRACK SUSPENSION SYSTEM**

2009English

INSTALLATION MANUAL OF TRACK SUSPENSION SYSTEM

## PREFACE OF INSTALLATION

Installation of DurkeeSox system is very easy, much simpler than other traditional air ducts. And the nice appearance and high quality style of DurkeeSox system can be better presented by track installation. Meanwhile, DurkeeSox system can be removed from the end by simply opening the zip at the inlet, so the cleaning and maintenance are more convenient.

The major material used to install DurkeeSox system includes: air ducts and its fittings (inlet, end, T-connector, elbow, transition, etc.), components (PAD-Pressure Adjustment Device, ACD- Airflow Control Device, FAF -fabric air filter, static plenum box, etc.) and accessories (track, eyebolt, fastening, cable clamp, rubber jacket, etc.), which are supplied by the manufacturer (shipped with the consignment, including installation drawing, installation manual and assembly drawing, etc.) Other installation auxiliaries required on jobsite, such as ,fixing brackets, fastening bolts and screws shall be purchased by the installation contractor.

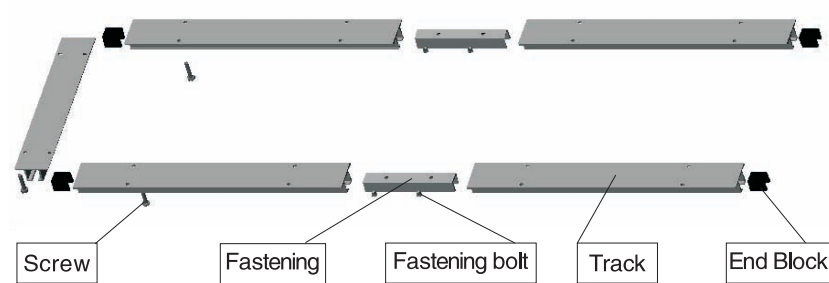

Flush Mount Accessories



Picture of Flush Mount Accessories

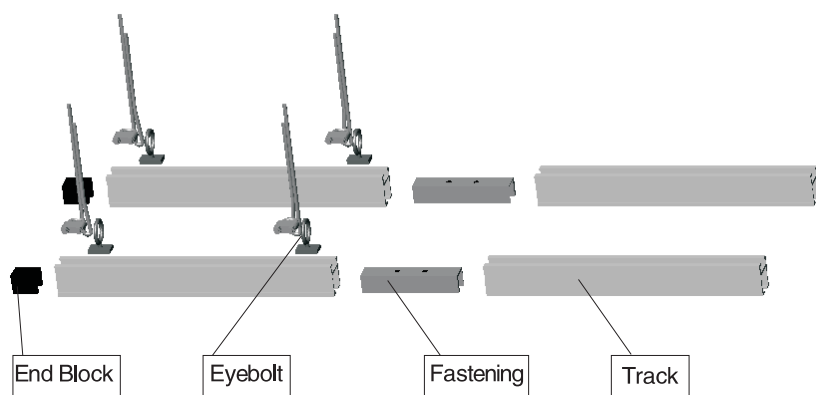

H-track Accessories

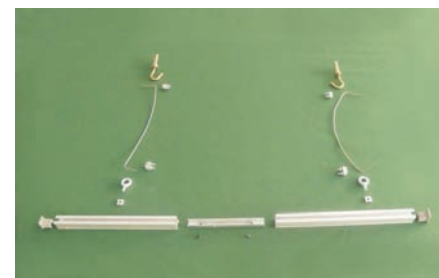

Picture of H-track Accessories

Although the installation of DurkeeSox system is quite easy, attention must be paid to the details: locating dimensions of track, installation angle of inlets, straightness of duct, etc. Otherwise, they would affect the appearance of DurkeeSox system despite of no influence on ventilation.

## Installation Manual of Track Suspension System

### CONTENTS

1、 Basic introduction to installation style.....	01-03
1.1 Type of track installation	
1.2 Inlet reservation and connection mode	
1.3 End installation method	
1.4 Installation of irregular fittings	
2、 Preparation and calculation before installation.....	04-07
2.1 Preparation of installation tools	
2.2 Construction drawings and accessories calculation	
2.3 Engineering solution	
3、 Installation procedure and implementation.....	08-12
3.1 Unpacking of main material box	
3.2 Unpacking of accessory box	
3.3 Installation of H-track	
3.4 Installation of Flush Mount	
3.5 Installation adjustment and system suspension	

# 1 BASIC INTRODUCTION TO INSTALLATION STYLE

## 1.1 Type of track installation

### 1.1.1 Rail consists of Flush Mount and H-track in terms of installation method

#### 1.1.1.1 Flush Mount

DurkeeSox systems of half-round, large half-round and quarter-round use Flush Mount

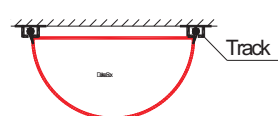
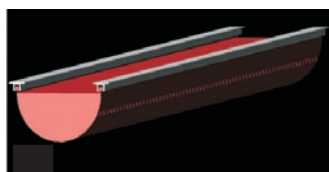

Half-round, Large half-round Flush Mount

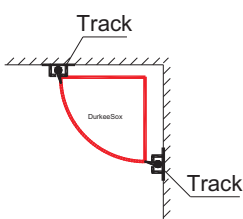

Quarter-round Flush Mount

#### 1.1.1.2 H-track

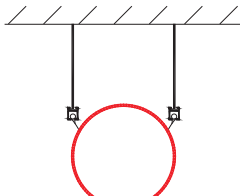
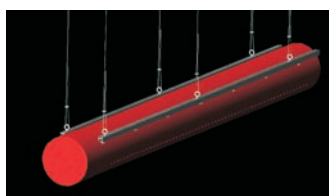

Double-Row H-track (2:00, 10:00)

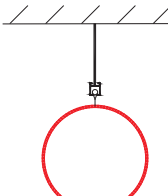
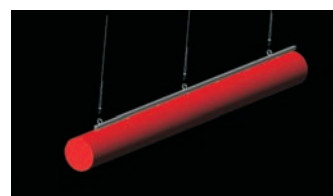

Single-Row H-track (12:00)

Double-row H-track also includes 3:00, 9:00 and other special cases

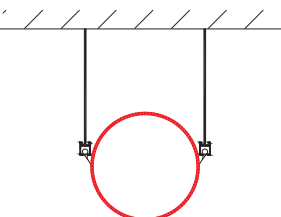

Double-Row H-track (3:00, 9:00)

Single-row suspension is very simple and practical when the time of non-ventilation is very short or no requirements are placed on appearance. However, when good looking is required or the large-diameter duct shall bear weight, it is a must to select double-row suspension system. In special cases, the clock direction of suspension can be defined by the user.

**Note:**  
if no direction is defined in the construction specification, the direction is 12:00 for single-row, 2:00 and 10:00 for double-row. Other directions will be specified.

### 1.1.2 According to the mating of DurkeeSox duct and track, the connection mode includes sliding block and sliding bar.

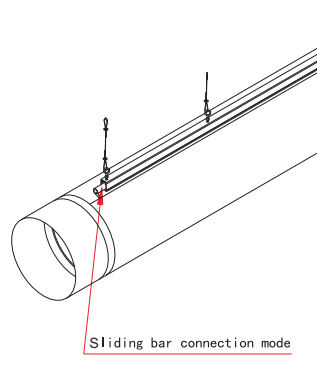
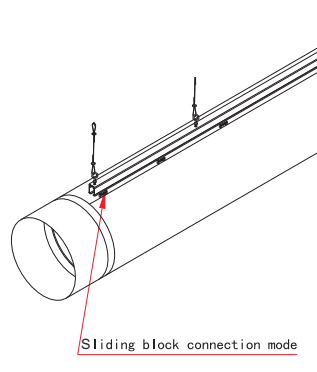

Sliding block connection mode

Sliding bar connection mode

## 1.2 Inlet reservation and connection

### 1.2.1 Inlet for H-track suspension

According to the shape of reserved outlet of metal duct, inlet connection consists of round & square-to-round connection

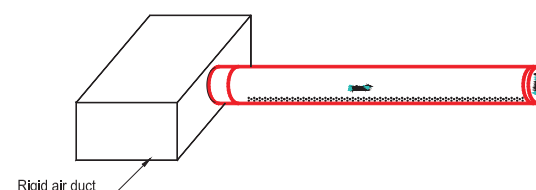

Round Connection

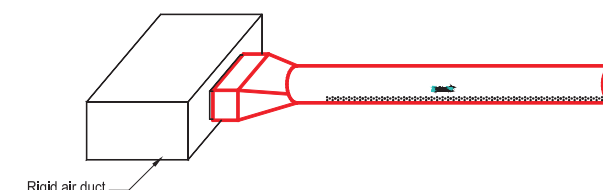

Square-to-round Connection

### 1.2.2 Inlet for Flush Mount suspension

In terms of shape of reservation joint, the inlet connection mode includes square and round profiles for both end inlet and top inlet.

#### End inlet

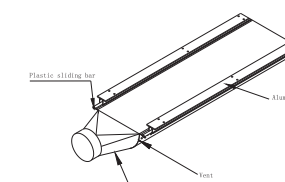

Round to half-round end inlet

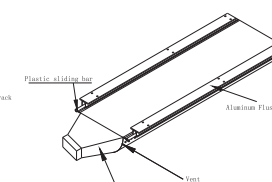

Square to half-round end inlet

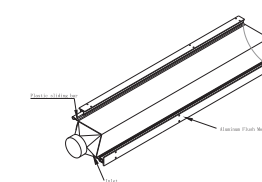

Round to quarter-round end inlet

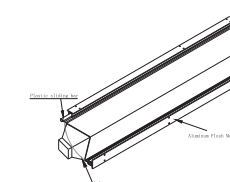

Square to quarter-round end inlet

#### Top inlet

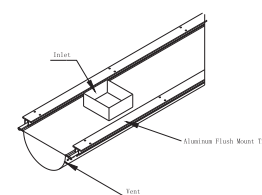

Half-round top square inlet

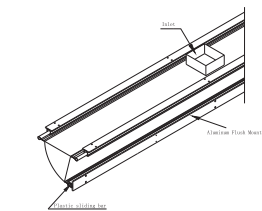

Quarter-round top square inlet

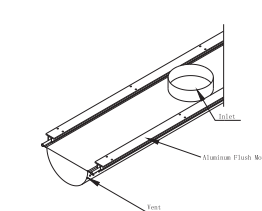

Half-round top round inlet

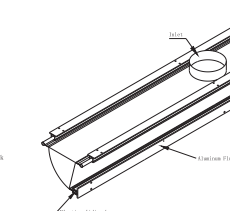

Quarter-round top round inlet

## 1.3 End installation method

### 1.3.1 Type of End for H-track

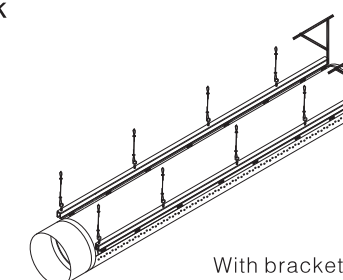

With bracket

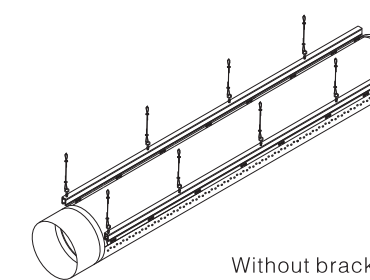

Without bracket

### 1.3.2 Type of end for Flush Mount



With track



Without track

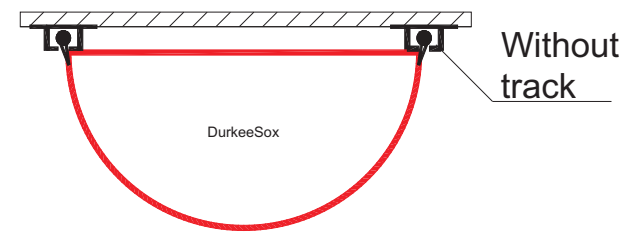
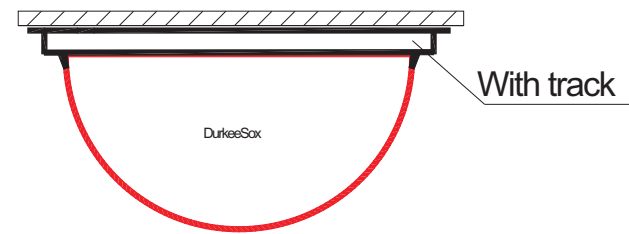

### 1.4 Installation of irregular fittings

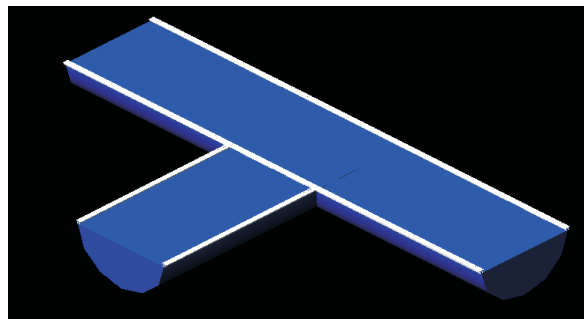

T-connection

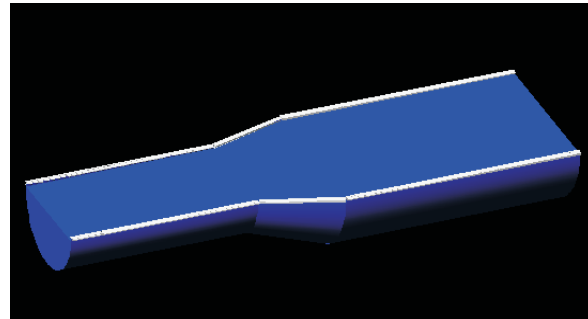

Transition

## 2 PREPARATION AND CALCULATION BEFORE INSTALLATION

### 2.1 Preparation of installation tools

Common tools for DurkeeSox system installation



#### Function of different tools:

- (1) Electric drill: drill for bracket, drill and rivet for DurkeeSox system and metal duct outlet, drill for suspended ceiling to fix the track.
- (2) Percussion drill: drill in the wall and use expansion blot to fix bracket onto the wall.
- (3) Power switchboard: convenient electric tool for works at a long distance.
- (4) Hammer: fix bracket.
- (5) Plier: fix cable clamp.
- (6) Spanner: fix bracket and tighten cable clamp.
- (7) Tape measure: measure size and for locating.
- (8) Mark pen: make and record for data.
- (9) Safety belt: provide protection for aloft work.
- (10) Chalk line bag: locate track suspension on the ceiling.
- (11) Plumb bob: locate the suspension point along the upright direction.
- (12) Manual rivetting gun: used to connect DurkeeSox system and metal duct.
- (13) Scaffold: used for aloft work.



## 2.2 Construction drawing and accessories calculation

### 2.2.1 Make detailed construction drawing according to the design drawing of DurkeeSox system

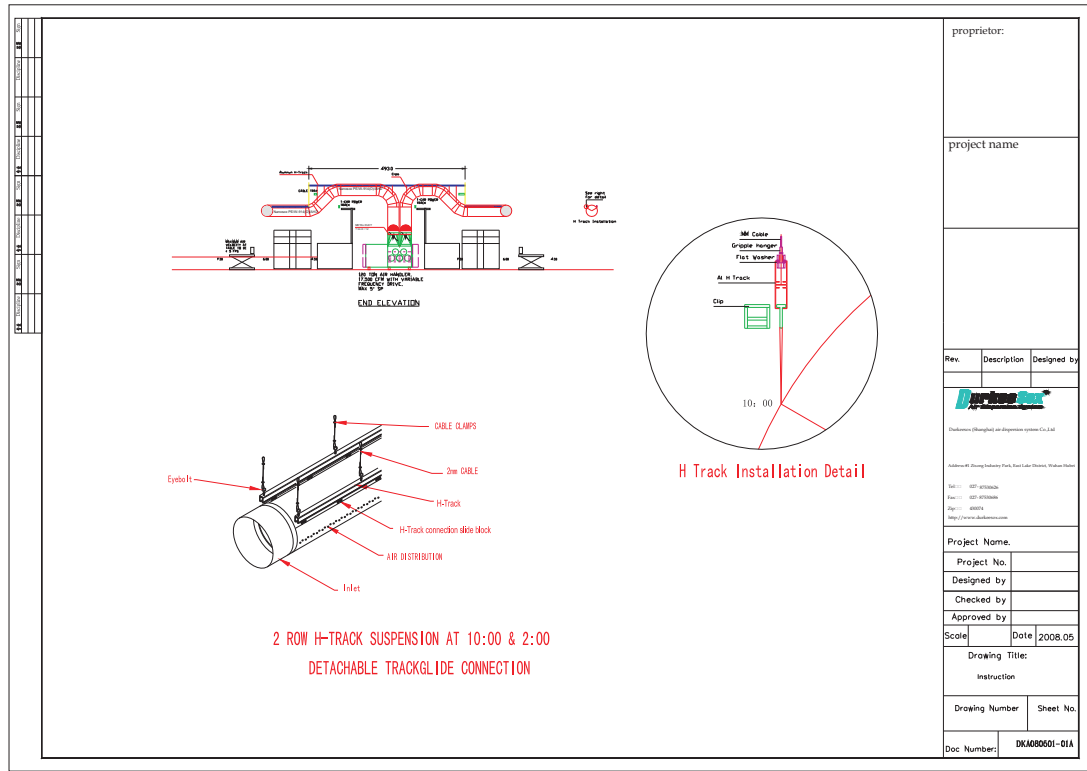

Make construction drawing; it shall be able to indicate how and where to install the bracket of each duct length as well as the installation height of the track suspension and spacing between tracks. Accessories calculation shall be based on precise length, installation height and installation position.

### 2.2.2 Calculate track locating height and spacing between tracks per duct dia.

#### 2.2.2.1 Location and dimension of Flush Mount

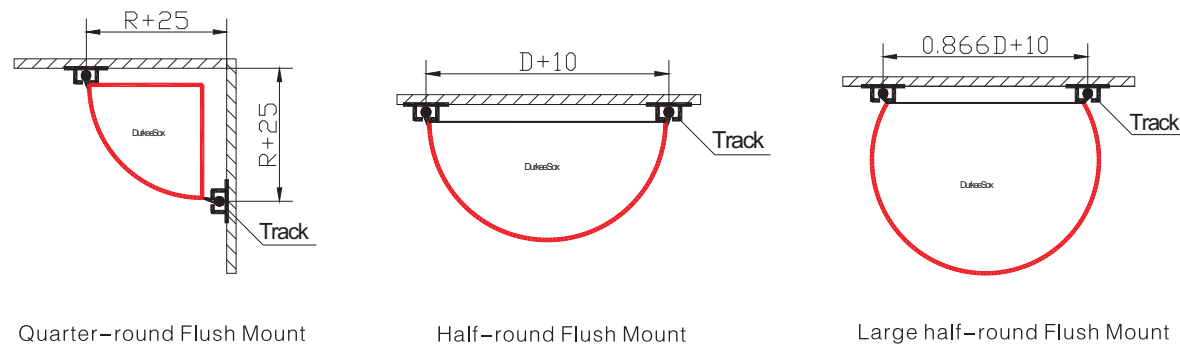

#### 2.2.2.2 Location and dimension of H-track

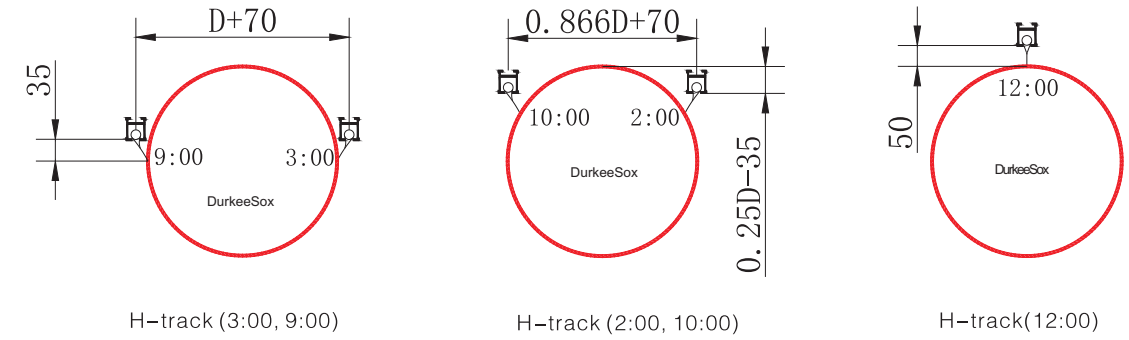

Track spacing and height comparison table for H-track per duct dia.

Dia (inch mm)	2: 00 & 10: 00				3:00 & 9:00			
	Track spacing (inch mm)	height from track to top of duct (inch mm)	Track spacing (inch mm)	height from track to top of duct (inch mm)	Track spacing (inch mm)	height from track to top of duct (inch mm)	Track spacing (inch mm)	height from track to top of duct (inch mm)
6	152	7 <sup>15</sup> / <sub>16</sub> 201	1 <sup>1</sup> / <sub>8</sub> 3	8 <sup>3</sup> / <sub>4</sub> 222	1 <sup>1</sup> / <sub>8</sub> 41			
8	203	9 <sup>11</sup> / <sub>16</sub> 245	1 <sup>1</sup> / <sub>8</sub> 15	10 <sup>3</sup> / <sub>4</sub> 273	2 <sup>1</sup> / <sub>8</sub> 66.5			
10	254	11 <sup>3</sup> / <sub>8</sub> 289	1 <sup>1</sup> / <sub>8</sub> 28	12 <sup>3</sup> / <sub>4</sub> 324	3 <sup>1</sup> / <sub>8</sub> 92			
12	305	13 <sup>1</sup> / <sub>8</sub> 334	1 <sup>1</sup> / <sub>8</sub> 41	14 <sup>3</sup> / <sub>4</sub> 375	4 <sup>1</sup> / <sub>8</sub> 117.5			
14	356	14 <sup>7</sup> / <sub>8</sub> 378	2 <sup>1</sup> / <sub>8</sub> 54	16 <sup>3</sup> / <sub>4</sub> 426	5 <sup>1</sup> / <sub>8</sub> 143			
16	406	16 <sup>9</sup> / <sub>16</sub> 421	2 <sup>1</sup> / <sub>8</sub> 66	18 <sup>3</sup> / <sub>4</sub> 476	6 <sup>1</sup> / <sub>8</sub> 168			
18	457	18 <sup>5</sup> / <sub>16</sub> 465	3 <sup>1</sup> / <sub>8</sub> 79	20 <sup>3</sup> / <sub>4</sub> 527	7 <sup>1</sup> / <sub>8</sub> 193.5			
20	508	20 509	3 <sup>1</sup> / <sub>8</sub> 92	22 <sup>3</sup> / <sub>4</sub> 578	8 <sup>1</sup> / <sub>8</sub> 219			
22	559	21 <sup>13</sup> / <sub>16</sub> 554	4 <sup>1</sup> / <sub>8</sub> 104	24 <sup>3</sup> / <sub>4</sub> 629	9 <sup>1</sup> / <sub>8</sub> 244.5			
24	610	23 <sup>9</sup> / <sub>16</sub> 598	4 <sup>1</sup> / <sub>8</sub> 117	26 <sup>3</sup> / <sub>4</sub> 680	10 <sup>1</sup> / <sub>8</sub> 270			
26	660	25 <sup>1</sup> / <sub>4</sub> 641	5 <sup>1</sup> / <sub>8</sub> 130	28 <sup>3</sup> / <sub>4</sub> 730	11 <sup>1</sup> / <sub>8</sub> 295			
28	711	26 <sup>15</sup> / <sub>16</sub> 685	5 <sup>1</sup> / <sub>8</sub> 142	30 <sup>3</sup> / <sub>4</sub> 781	12 <sup>1</sup> / <sub>8</sub> 320.5			
30	762	28 <sup>1</sup> / <sub>8</sub> 729	6 <sup>1</sup> / <sub>8</sub> 155	32 <sup>3</sup> / <sub>4</sub> 832	13 <sup>1</sup> / <sub>8</sub> 346			
32	813	30 <sup>1</sup> / <sub>2</sub> 774	6 <sup>1</sup> / <sub>8</sub> 168	34 <sup>3</sup> / <sub>4</sub> 883	14 <sup>1</sup> / <sub>8</sub> 371.5			
34	864	32 <sup>3</sup> / <sub>16</sub> 818	7 <sup>1</sup> / <sub>8</sub> 181	36 <sup>3</sup> / <sub>4</sub> 934	15 <sup>1</sup> / <sub>8</sub> 397			
36	914	33 <sup>7</sup> / <sub>8</sub> 861	7 <sup>1</sup> / <sub>8</sub> 193	38 <sup>3</sup> / <sub>4</sub> 984	16 <sup>1</sup> / <sub>8</sub> 422			
38	965	35 <sup>5</sup> / <sub>8</sub> 905	8 <sup>1</sup> / <sub>8</sub> 206	40 <sup>3</sup> / <sub>4</sub> 1035	17 <sup>1</sup> / <sub>8</sub> 447.5			
40	1016	37 <sup>3</sup> / <sub>8</sub> 949	8 <sup>1</sup> / <sub>8</sub> 219	42 <sup>3</sup> / <sub>4</sub> 1086	18 <sup>1</sup> / <sub>8</sub> 473			
42	1067	39 <sup>1</sup> / <sub>8</sub> 994	9 <sup>1</sup> / <sub>8</sub> 231	44 <sup>3</sup> / <sub>4</sub> 1137	19 <sup>1</sup> / <sub>8</sub> 498.5			
44	1118	40 <sup>7</sup> / <sub>8</sub> 1038	9 <sup>1</sup> / <sub>8</sub> 244	46 <sup>3</sup> / <sub>4</sub> 1188	20 <sup>1</sup> / <sub>8</sub> 524			
46	1168	42 <sup>9</sup> / <sub>16</sub> 1081	10 <sup>1</sup> / <sub>8</sub> 257	48 <sup>3</sup> / <sub>4</sub> 1238	21 <sup>1</sup> / <sub>8</sub> 549			
48	1219	44 <sup>5</sup> / <sub>16</sub> 1125	10 <sup>1</sup> / <sub>8</sub> 269	50 <sup>3</sup> / <sub>4</sub> 1289	22 <sup>1</sup> / <sub>8</sub> 574.5			
50	1270	46 1169	11 <sup>1</sup> / <sub>8</sub> 282	52 <sup>3</sup> / <sub>4</sub> 1340	23 <sup>1</sup> / <sub>8</sub> 600			
52	1321	47 <sup>3</sup> / <sub>4</sub> 1213	11 <sup>1</sup> / <sub>8</sub> 295	54 <sup>3</sup> / <sub>4</sub> 1391	24 <sup>1</sup> / <sub>8</sub> 625.5			
54	1372	49 <sup>1</sup> / <sub>2</sub> 1258	12 <sup>1</sup> / <sub>8</sub> 308	56 <sup>3</sup> / <sub>4</sub> 1442	25 <sup>1</sup> / <sub>8</sub> 651			
56	1422	51 <sup>1</sup> / <sub>4</sub> 1301	12 <sup>1</sup> / <sub>8</sub> 320	58 <sup>3</sup> / <sub>4</sub> 1492	26 <sup>1</sup> / <sub>8</sub> 676			
58	1473	52 <sup>15</sup> / <sub>16</sub> 1345	13 <sup>1</sup> / <sub>8</sub> 333	60 <sup>3</sup> / <sub>4</sub> 1543	27 <sup>1</sup> / <sub>8</sub> 701.5			
60	1524	54 <sup>11</sup> / <sub>16</sub> 1389	13 <sup>1</sup> / <sub>8</sub> 346	62 <sup>3</sup> / <sub>4</sub> 1594	28 <sup>1</sup> / <sub>8</sub> 727			
62	1575	56 <sup>7</sup> / <sub>16</sub> 1433	14 <sup>1</sup> / <sub>8</sub> 358	64 <sup>3</sup> / <sub>4</sub> 1645	29 <sup>1</sup> / <sub>8</sub> 752.5			
64	1626	58 <sup>3</sup> / <sub>16</sub> 1478	14 <sup>1</sup> / <sub>8</sub> 371	66 <sup>3</sup> / <sub>4</sub> 1696	30 <sup>1</sup> / <sub>8</sub> 778			
66	1676	59 <sup>7</sup> / <sub>8</sub> 1521	15 <sup>1</sup> / <sub>8</sub> 384	68 <sup>3</sup> / <sub>4</sub> 1746	31 <sup>1</sup> / <sub>8</sub> 803			
68	1727	61 <sup>5</sup> / <sub>16</sub> 1565	15 <sup>1</sup> / <sub>8</sub> 396	70 <sup>3</sup> / <sub>4</sub> 1797	32 <sup>1</sup> / <sub>8</sub> 828.5			
70	1778	63 <sup>5</sup> / <sub>16</sub> 1609	16 <sup>1</sup> / <sub>8</sub> 409	72 <sup>3</sup> / <sub>4</sub> 1848	33 <sup>1</sup> / <sub>8</sub> 854			
72	1829	65 <sup>1</sup> / <sub>16</sub> 1653	16 <sup>1</sup> / <sub>8</sub> 422	74 <sup>3</sup> / <sub>4</sub> 1899	34 <sup>1</sup> / <sub>8</sub> 879.5			

### 2.2.3 Calculation of accessories for installation

- A、 Figure out the quantity of DurkeeSox system and the length of each duct according to the installation drawing.
- B、 Figure out the accessories for installation of each duct and sum up.
- C、 How to calculate accessories:  
The company has designed the accessory calculation table into which the duct diameter and length can be entered directly, and the table can generate automatically the quantity of accessories required by each duct and the total quantity required by the project.

#### Installation materials for Flush Mount

Duct ID Number	Dia In mm	L ft	L mm	Suspension Rows	Track ft	Track mm	Fastening Pcs	End Block Pcs	Rubber jacket ft	Rubber jacket mm	
1	26	660	57.6	17.55	2	118	36	18	4	7.1	2.18
2	26	660	60.9	18.55	2	124.7	38	19	4	7.1	2.18
3	26	660	60.9	18.55	2	124.7	38	19	4	7.1	2.18
4	26	660	60.9	18.55	2	124.7	38	19	4	7.1	2.18
5	26	660	60.9	18.55	2	124.7	38	19	4	7.1	2.18
6	26	660	60.9	18.55	2	124.7	38	19	4	7.1	2.18
7	26	660	60.9	18.55	2	124.7	38	19	4	7.1	2.18
8	26	660	60.9	18.55	2	124.7	38	19	4	7.1	2.18
9	26	660	60.9	18.55	2	124.7	38	19	4	7.1	2.18
10	26	660	60.9	18.55	2	124.7	38	19	4	7.1	2.18
Total	10	605.7	184.5	0	1240.3	378	189	40	71	21.8	
Project total quantity					1242	378	189	40		0	

How to calculate each accessory in the table: The accessories of Flush Mount include track, fastening, end block and rubber jacket.  
**Track length:** duct length X rows of track (add an excess slightly, e.g. 5%)  
**Fastening:** according to the quantity of track, each 6.6' long connected by fastenings. The quantity of fastening can be estimated as length of track /2 (add an excess slightly, e.g. 5%)  
**End block:** Both ends of each track shall wear a block (if both ends of lateral track are in alignment with the outside of longitudinal rail, end block is unnecessary for the end of the longitudinal track here). Therefore, each duct needs 4 end blocks.  
**Rubber jacket:** in case of ventilation, since the metal duct outlet needs no insulation, it shall wear rubber jacket to protect the DurkeeSox system. The length of rubber jacket is determined as follows: perimeter of each inlet X 1.05.

#### Installation materials for H-track

Duct ID Number	Dia in mm	L ft	L mm	Suspension Rows	Track ft	Track mm	Fastening Pcs	Eyebolt Pcs	End block Pcs	Square nut Pcs	1/16" Cable ft	1/16" Cable mm	Rubber jacket ft	Rubber jacket mm	
1	26	660	57.6	17.55	2	118	36	18	18	4	18	177.2	54	7.2	2.2
2	26	660	60.9	18.55	2	124.7	38	19	19	4	19	187	57	7.2	2.2
3	26	660	60.9	18.55	2	124.7	38	19	19	4	19	187	57	7.2	2.2
4	26	660	60.9	18.55	2	124.7	38	19	19	4	19	187	57	7.2	2.2
5	26	660	60.9	18.55	2	124.7	38	19	19	4	19	187	57	7.2	2.2
6	26	660	60.9	18.55	2	124.7	38	19	19	4	19	187	57	7.2	2.2
7	26	660	60.9	18.55	2	124.7	38	19	19	4	19	187	57	7.2	2.2
8	26	660	60.9	18.55	2	124.7	38	19	19	4	19	187	57	7.2	2.2
9	26	660	60.9	18.55	2	124.7	38	19	19	4	19	187	57	7.2	2.2
10	26	660	60.9	18.55	2	124.7	38	19	19	4	19	187	57	7.2	2.2
Total	10	605.7	184.5	0	1240.3	378	189	189	40	189	1860	567	72	22	
Project total quantity					1240.3	378	189	189	40	200	1870	570		0	

Calculation of the accessories of H-track includes track, fastening, end block, eyebolt, square nut, 1/16" galvanized cable and rubber jacket (2 end caps needed by a duct for single-row suspension), rubber jacket is the same as that of Flush Mount.

Calculation of eyebolt and square nut: each eyebolt shall have a square nut, so the quantity of eyebolt is the same as that of square nut.

A suspension point is needed for every 6.6', so the quantity of eyebolt and square nut is length of track /2

1/16" (2mm) galvanized cable: hanging rail is suspended by 1/16" galvanized cable, fixed with eyebolt. The length of 1/16" galvanized cable is: quantity of eyebolt X height of suspension.

## 2.3 Engineering solution

Make construction drawing according to the actual condition on the site.

According to site condition and the progress of each work type, figure out the specified installation time and construction period; determine the form and size of bracket and then figure out the quantity of materials for installation.

## 3 INSTALLATION PROCEDURE AND IMPLEMENTATION

### 3.1 Unpacking of main material box



1 Find out Box No. 1 in the main material box



2 Open No. 1 main material box and take out the general assembly drawing.



3 Correspond the general assembly drawing to the articles and find out the corresponding duct segments for installation

### 3.2 Unpacking of accessory box



1 Find out Box No. 1 in the accessory box



2 Open No. 1 accessory box and take out the general assembly drawing.



3 Correspond to the accessory box with the help of the general assembly drawing.

Each duct of standard length for the DurkeeSox system has been put into a plastic bag, containing a product installation and assembly drawing, which has the information on the corresponding duct diameter, length, orifice direction and the specific position for installation. Furthermore, there is a label at the inlet or near zip inside the duct for each duct segment. The label indicates the diameter, length, duct and segment code of the duct.

### 3.3 Installation of H-track

#### 3.3.1 Installation of track suspension



1 Measure and mark

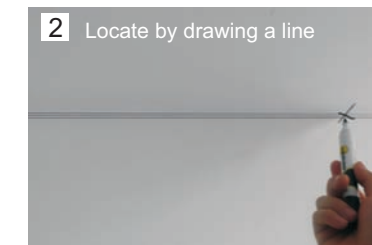

2 Locate by drawing a line



3 Installation of expansion hook

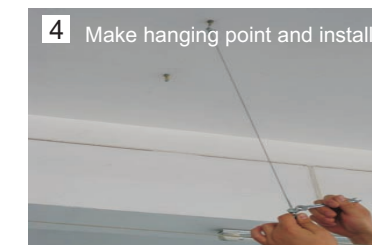

4 Make hanging point and install

The expansion hooks for the same track shall be in the same line.



### 3.3.2 Mount track

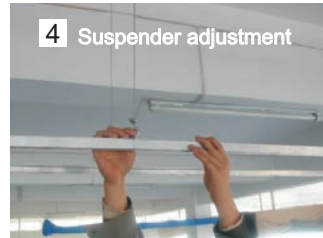
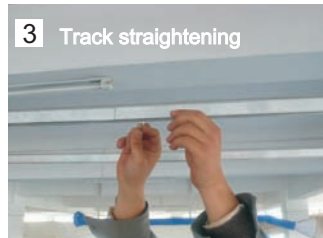
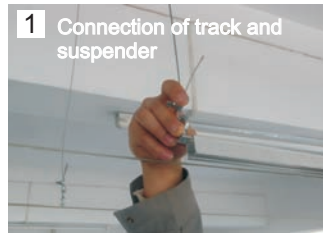

Install track from the inlet, insert fastening, connect the second track to install a whole track in order, and adjust the track to horizontal level.

### 3.3.4 Inlet installation



If planned to extend insulation to outlet of metal duct (usually 1/4"), rubber jacket can be exempted. Rivetting is made as per the spacing of about 6". Upon inlet installation, the zip between inlet and the duct can be closed up to align with the installation angle of the inlet (if the inlet angle is wrong, it may wrinkle the DurkeeSox duct).

### 3.3.5 Hanging duct

From the end, insert the slide bar or block into the slide slot of the track and straighten the duct towards the inlet.

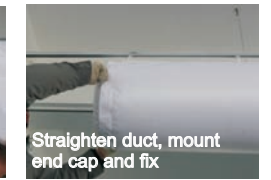
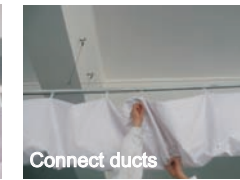

Note: when being suspended, the duct shall not touch the ground to avoid contamination.

### 3.4 Installation of Flush Mount

#### 3.4.1 Measurement and location

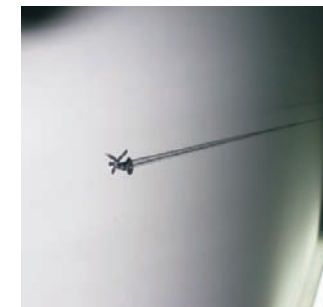
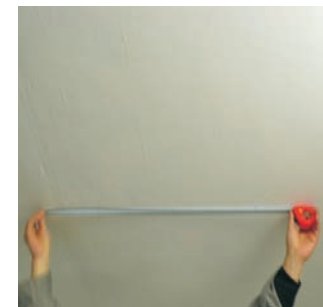

Map or pull line on the ceiling by chalk line bag or drawing line to determine the position of track to be mounted.

#### 3.4.2 Installation and connection of track

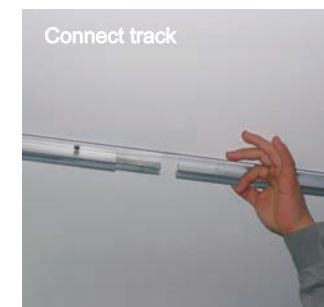
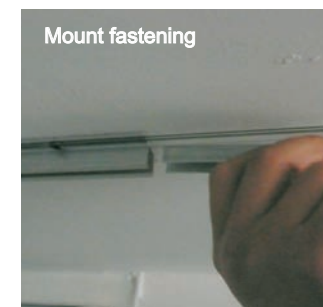
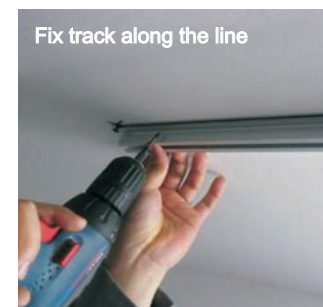

After finishing rail installation at the inlet, the duct may be too long or short, so the track at the end shall be installed after straightening duct and measuring the actual size.

When installing track on the 24"x24" mineral wool ceiling, align the bolt on the track directly with the keel. So, there may be a distance at the front and rear of the whole track. Measure the size and install the track at this part.

Adjust tracks to flat and straight after all of them are installed.

### 3.4.3 Hanging duct

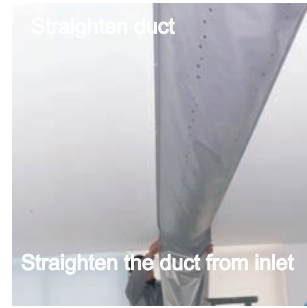
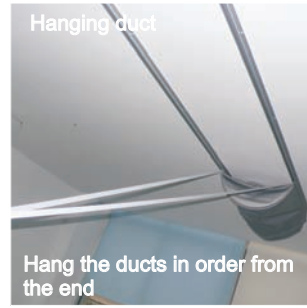
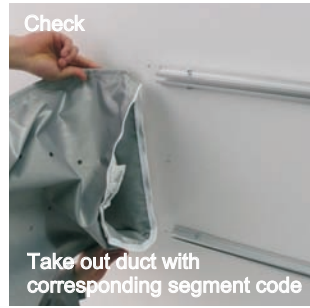

From the end, insert the slide bar or block into the slide slot of the track and straighten the duct towards the inlet.

### 3.4.4 Inlet installation



End inlet installation: mainly in the form of rivetting. Pay attention to the inlet installation angle: all the zip heads face down at the direction of 6:00.

Top inlet installation: splice it in the form of nylon hasp. After connection of the top inlet, align the position of straight duct segment and press it upward with hand to splice the inlet tightly to the hasp on the straight duct.

### 3.4.5 Fix track at the end

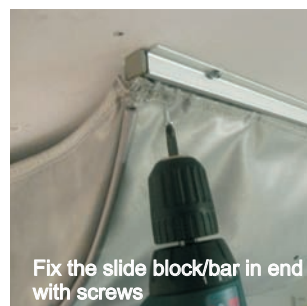

### 3.5 Installation adjustment and system suspension

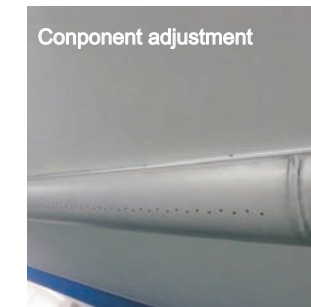
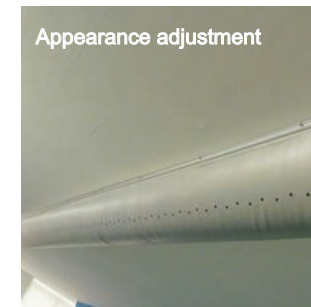
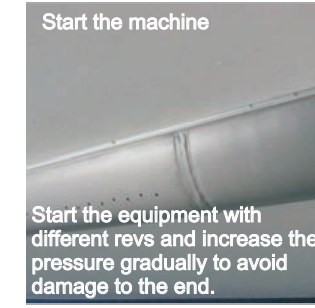
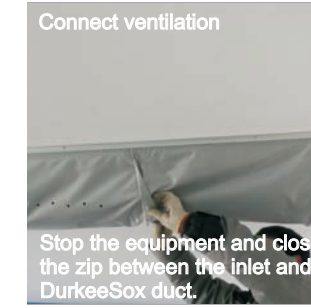
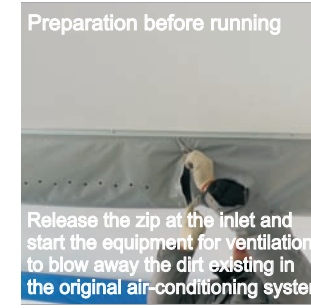

1. Visual inspection: the system should be straight without any wrinkle by visual inspection.
2. Component adjustment: adjust PAD and ACD to balance the pressure among branch ducts and make the pressure throughout the system generally consistent.

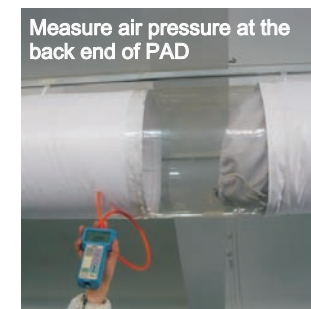





THE EXPERT IN AIR DISPERSION INDUSTRY WORLD WIDE

## DURKEESOX ( SHANGHAI ) AIR DISPERSION SYSTEM CO.,LTD



### CHINA SALES CENTER

No.1 Zisong Industry Zone,Hongshan District,Wuhan,China  
Tel: 86-27-87530626  
Fax: 86-27-87530686  
Email: sox@durkeesox.com



### ASIAN SALES CENTER

Tel: 86-27-87530815  
Fax: 86-27-87530686  
Email: durkee@durkeesox.com

## DURKEE AMERICA, INC.



### AMERICA SALES CENTER

#8141 Explorers Walk. Vancouver, BC.  
V5S 4A9 Canada  
Tel / 001. 604. 324. 8048  
E-mail / info@durkeesox.com

Distributor Data